

MFJ-1762 Instruction Manual

INTRODUCTION

Thank you for purchasing the MFJ-1762 three-element six-meter Yagi. The MFJ-1762 is a light-weight directional antenna especially designed for installation with readily-available TV-type masts, mounts, and hardware. The driven element employs a "no-tune" hairpin impedance matching system, and all elements are cut to exact length at the factory. No adjustment should be needed for coverage of the 50-MHz SSB band (see page 8 for FM-segment tuning instructions). Because of its compact size, light weight, and unique construction, the MFJ-1762 is also an excellent choice for six-meter portable or "rover" operation. In weak-signal DX applications, two MFJ-1762s may be stacked for increased capture area and 3-dB additional gain. The MFJ-1762 has been computer modeled on both ELNEC™ and YA™ to confirm design integrity, and has been thoroughly field tested in northern climates for winter survivability.

TYPICAL SPECIFICATIONS

Boom length	6'
Turning Radius	5' 8"
Longest Element	117-1/2"
Weight	2.5 lbs.
Feed Impedance	50Ω
Resonant Frequency	50.3 MHz
1.5:1 VSWR Bandwidth	1.7 MHz
Forward Gain	6.0 dBd (8.2 dBi)
Front-to-Rear Ratio	>18 dB measured
Maximum Power	150 Watts

SAFETY PRECAUTIONS

Before assembling, please read the following safety notice:

This antenna is an electrical conductor--do not handle or mount near power lines, service entrances, or other dangerous power sources. Mount out of the reach of adults, children, and animals. Antenna elements develop lethal voltages and may cause severe RF burns during transmitter operation. For lightning protection, always ground your supporting mast to two or more outdoor ground rods. Disconnect the feedline from your radio when not in use. Do not expose pacemakers or other bio-medical equipment to strong RF radiation. To avoid personal injury or damage to the antenna, plan all mechanical aspects of your installation carefully. Avoid handling heavy or unwieldy masts by yourself, and make sure a second person is available to assist you in an emergency. Never work on a roof or climb a tower alone!

MFJ-1762 PARTS LIST

To begin, confirm that all necessary parts have been supplied with your antenna package:

- (1) - 6' x 1-1/8" OD boom
- (2) - 54" x 1/4" OD element section (director)
- (2) - 54-1/2" x 1/4" OD element section (driven element)
- (2) - 59-1/4" x 1/4" OD element section (reflector)
- (1) - 5/16" x 1/4" OD spacer
- (1) - hairpin inductor
- (2) - "L" bracket
- (1) - 1 3/4" x 6-32 screw
- (6) - 1/2" x 10-32 screw
- (2) - 1/2" x 6-32 screw
- (1) - 6-32 Kep-nut
- (2) - 6-32 nut
- (2) - 6-32 flat washer
- (2) - 6-32 lock washer
- (4) - Insulated polyethylene element-mounting grommets
- (2) - #6 solder lug
- (1) - 1 - U-bolt mounting hardware kit (U-bolt, mast clamp, nuts)
- (1) - Tube of Loctite™

If any parts are damaged or omitted, please contact *MFJ Technical Service* at 601-323-0549 or the *MFJ Factory* at 601-323-5869 to arrange for replacement.

TOOLS

You'll need a selection of common household tools to construct your antenna:

- Phillips-head screw driver (#2)
- Straight-blade screw driver
- Pliers
- Utility knife or Ex-acto™ knife with #11 blade
- Soldering Set-up

SUGGESTED ANTENNA MATERIALS

- RG8-M Coax (also RG59 if stacking antennas)
- Sealant (Seal-All™) or equivalent
- Plastic electrical tape

SUGGESTED TEST EQUIPMENT

- MFJ-259 RF Analyzer or VSWR bridge

CONSTRUCTION:

- [] Begin by laying the boom on a flat surface. Find the driven-element holes and the two sets of mast-mount holes (one for vertical and one for horizontal mounting). The mast-mount holes are toward the *reflector* end of the antenna. Identify the director and reflector ends of the boom before starting assembly.
- [] Find two (2) 54" director element sections and identify the tapped end of each. Insert the tapped ends into the 1/4" holes drilled at the director end of the boom. Secure each in place with 10-32 screws. If you do not anticipate disassembling your beam, apply a drop of Locktite to each screw. Grip the element section gently with pliers when tightening.

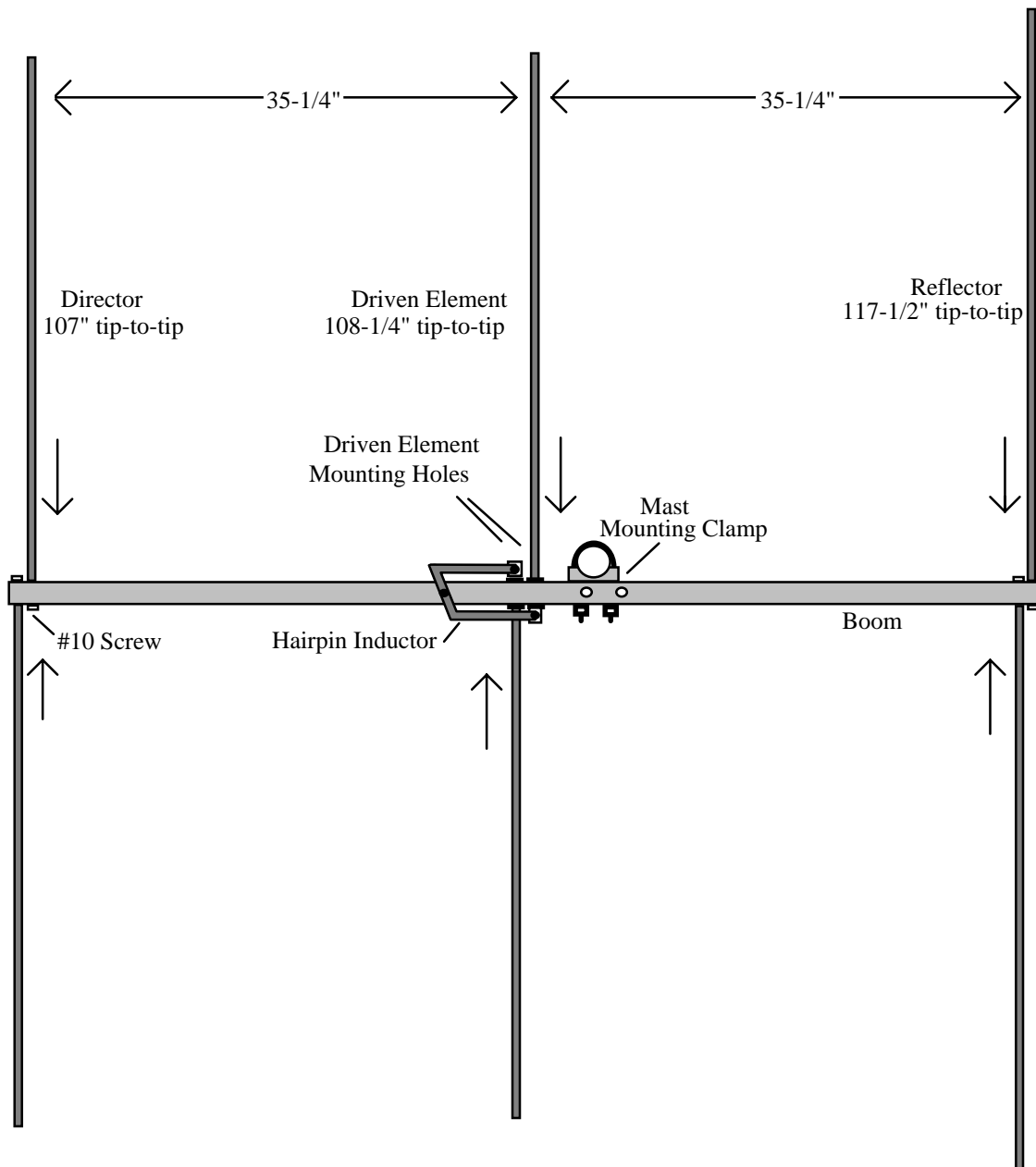

- [] Find two (2) 59-1/4" reflector element sections and repeat the same mounting procedure at the back end of the antenna.

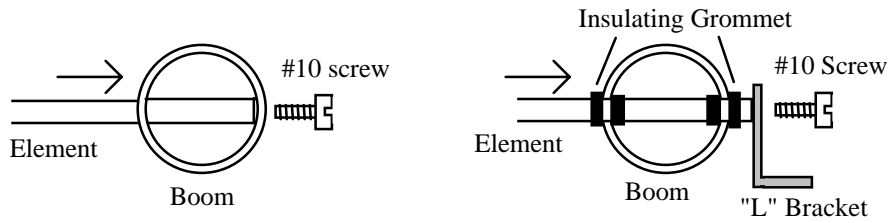

Director, Reflector Mounting Detail

Driven Element Mounting Detail

- [] Find four (4) black polyethylene insulating grommets and snap one into each driven-element mounting hole (do not confuse these holes with the U-bolt mounting holes).
- [] Locate the two remaining element sections (54-1/2" each) and slip the tapped end of each through the driven-element insulating grommets.
- [] Using 10-32 screws, install a "L" bracket on each driven element section as shown in the construction detail. Apply Loctite to the screws and secure firmly in place, using pliers to gently grip the element.
- [] Locate the aluminum hairpin inductor and install as shown below, using the 6-32 x 1 3/4" screw, the 5/16" x 1/4" OD spacer, and the 6-32 Kep-nut. Note that the end mounting holes on the hairpin should align with the driven element "L" brackets.

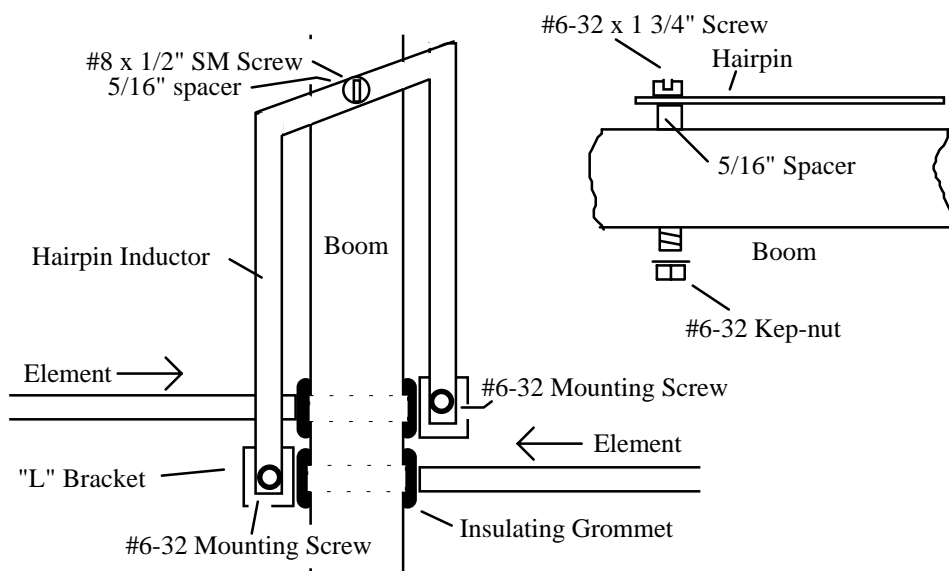

Hairpin Mounting Detail

- [] Temporarily fasten each "L" bracket to an end of the hairpin inductor with #6 hardware. The coaxial feedline will be connected to these points later on.
- [] Temporarily install the mast-mounting hardware (U-bolt can go on either way).

This completes initial mechanical assembly. Check all fasteners for tightness.

FEEDLINE INSTALLATION

For coax runs up to 70 feet, we recommend using RG8M (or mini-8) 1/4" diameter foam coax. This light-weight cable is available through most amateur radio dealers and is available in Radio Shack stores nationwide. RG8M performs well at 50-MHz and will handle 150 Watts with a reasonable margin of safety. Use the following steps to prepare your feedline:

- [] Strip back the outer insulation 1" and prepare the two conductors as pigtails--as shown in the diagram below.

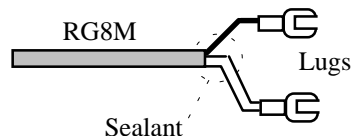

- [] Install a lug on each pigtail (crimp-type lugs should be crimped *and* soldered). **Pigtail length should not exceed 1-1/4"--including the lug. Excessively-long pigtails will detune the matching system.**
- [] Apply 2-3 thin coats of Seal-All™ to the exposed braid to retard water migration into the cable. If Seal-All is not available, use a rubberized contact cement or a silicon sealer. Allow sealant to dry thoroughly before handling the feedline.
- [] Connect each coax pig-tail to a feedpoint stud using the #6 hardware provided (do *not* use Loctite on these connections). Note that the hairpin is installed on the *bottom* (or earthward) side of the boom. When installing the MFJ-1762, the hairpin should be on the ground side and your coax should drop directly below the hairpin.

BALUN

The MFJ-1762 driven element is balanced. In order to prevent unwanted radiation from the feedline, we suggest installing a balun at the feedpoint. This need not be an elaborate or expensive addition--you can make a simple and effective choke-type balun using the feedline itself. To do this, form a 5-turn coil of RG8M just below the feedpoint using about 6' cable. Tape the coils together tightly with electrical tape and secure them to the mast. As an alternative, install three (3) FB43-5621 ferrite cores on the feedline at the feedpoint. Be sure to secure your feedline to the mast with electrical tape to provide stress relief at the feedpoint.

HORIZONTAL MOUNTING

The MFJ-1762 presents about the same mast-loading as a small TV antenna. This means you can erect it high and in the clear using standard TV mast, roof or chimney-mounting hardware, and a light-duty rotator. To avoid property damage or injury, plan your installation carefully and follow the same safety guidelines that apply to any TV-antenna installation. Be especially careful not to bend or mis-align elements when raising the mast. If you stack-mount the MFJ-1762 with other antennas, allow 5' vertical spacing between higher-frequency Yagis and 10' spacing between lower-frequency Yagis. Mounting the MFJ-1762 (or any Yagi) too close to existing antennas may distort the pattern--or raise the launch angle of your signal and compromise performance.

VERTICAL MOUNTING

The MFJ-1762 may also be mounted vertically for FM (or for West Coast SSB) operation. When mounting a single antenna vertically, precautions are needed to ensure that the mast and feedline do not upset the antenna's VSWR and radiation pattern. In order to prevent the mast from detuning the driven element, we recommend using a 8' fiberglass "painter's pole" as a mast. This will provide a strong RF-insulated support. Fiberglass poles are available at most large home-care centers. A wooden closet pole will also work--if weather-proofed with a uV-resistant finish. To prevent the feedline from detuning the driven element, run your coax down the boom to the reflector end, then let it drop down behind the reflector and below the rotor. If needed, use a short length of wooden dowel to extend the boom--this will keep the coax from hitting (and detuning) the reflector. Note that these precautions are *not* needed if you use a stacked pair of vertical beams. In this case, the vertical mast will be located mid-way between the antennas and will not interfere. A stacked pair is always preferable for vertical installations.

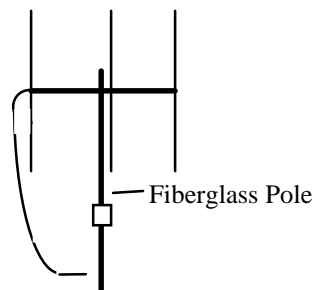

Single Vertical Mount

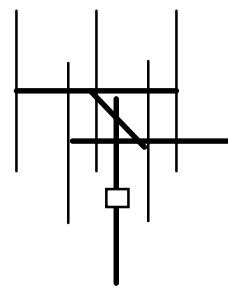

Stacked Vertical Mount

STACKING TWO MFJ-1762s

For best stacking performance, use 5/8-wave antenna separation. In most installations, a single 12' x 1-1/4" length of thin-wall 6061 aluminum mast may be used to support both antennas. For horizontal stacks, the first antenna should be mounted as close as possible to the rotor, and the second mounted at the top of the mast. This will provide approximately 11' 6" of spacing. In vertical installations, a 10' mast may be substituted

with only a minor loss in gain with both antennas mounted at the extreme ends of the pipe.

In order to feed two antennas with 50Ω line, you'll need to make a simple phasing and matching harness. The harness is made from readily-available 75Ω line. Either solid or foam-dielectric RG59 is suitable for this purpose. Prepare your harness as follows:

- [] Cut *one (1) electrical-wavelength* of RG59. Be sure to use the correct velocity factor for your particular cable (155-5/16" for 0.66 VF solid dielectric and 186" for 0.79 VF foam cable). If your cable has a different VF (velocity Factor), use the formula:

$$\text{Length in Inches} = 11800 \times \text{VF} / \text{Freq. in MHz}$$

- [] Install three (3) FB43-5621 ferrite sleeves at each end of the cable.
- [] Prepare pigtailed with lugs at each end (see previous instructions for RG8M).
- [] Cut the RG59 1/4-way down its total length and install PL-259's (at 38'3/4" for 0.66 VF solid or at 46-1/2" for 0.79 VF foam).
- [] Splice the RG59 back together using a coaxial type "T" adapter--this becomes the antenna array's 50-Ohm feedpoint.
- [] Connect pigtail ends to the antennas. Note that this "off-center fed" harness shifts signals 180-degrees out of phase. To correct for this, **be sure to transpose pigtail connections at the second antenna. If you don't do this, the yagis will be fed out-of-phase and signals will cancel rather than add! You must install the harness as shown below:**

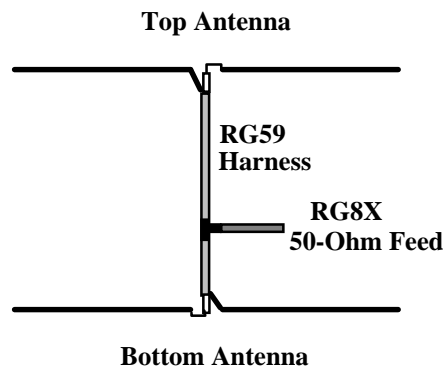

PORTABLE OPERATION WITH THE MFJ-1762

Although designed for permanent roof-top installations, your MFJ-1762 makes an ideal portable antenna. Its unique construction permits you to remove the elements in less than a minute for easy storage or travel. To prepare for transport, simply remove the six #10-32 element mounting screws and detach each element sections from the boom. The

feedline and hairpin assembly may remain attached. If you remove the U-bolt assembly, elements may be stored inside the boom.

TUNING THE MFJ-1762 FOR FM SUB-BAND OPERATION

The MFJ-1762 is easily retuned for operation in the FM portion of the six-meter band. To do this, simply re-cut the element sections as shown below using a hacksaw or tubing cutter. *Be careful not to cut the threaded ends when shortening elements!*

- [] Reflector sections, cut for 56-3/4" each.
- [] Driven element sections, cut for 52-3/8" each.
- [] Director sections, cut for 51-3/4" each.

This will provide minimum VSWR near the 52.525-MHz FM-simplex calling frequency, and should provide low VSWR on most 6-Meter FM-repeater input frequencies.

IN CASE OF DIFFICULTY

If you experience difficulty with your MFJ-1762, please check out the following possibilities before contacting the factory:

High VSWR or Intermittent operation:

- Inspect all connectors for a broken lead, water, ice, severe corrosion, or dirt.
- Inspect coax for kinks, chaffing, crushed areas, breaks in jacket, water infusion, etc.
- Inspect the antenna for loose or broken elements, broken coax pigtail, or debris.
- Check in-line devices such as amplifiers, coax switches, VSWR meters, etc.
- Check balun sleeves for damage from excessive RF heating.

No Sensitivity, Poor directivity:

- Improper phasing (stacked beams only).
- Extreme build up of ice and snow.

IMPORTANT NOTE: Rain, snow, or ice accumulating on antenna elements normally increases VSWR by lowering the antenna's resonant frequency. Precipitation detuning is normal for all VHF Yagis, and the MFJ-1762 is cut approximately 200 kHz high in frequency to help compensate for this effect in wet weather.

TECHNICAL ASSISTANCE

If you have any problem with this unit first check the appropriate section of this manual. If the manual does not reference your problem or your problem is not solved by reading the manual, you may call *MFJ Technical Service* at **601-323-0549** or the *MFJ Factory* at **601-323-5869**. You will be best helped if you have your unit, manual and all information on your station handy so you can answer any questions the technicians may ask.

You can also send questions by mail to MFJ Enterprises, Inc., 300 Industrial Park Road, Starkville, MS 39759; by FAX to 601-323-6551; through Compuserve at 76206,1763; or by email to mfj@mfjenterprises.com. Send a complete description of your problem, an explanation of exactly how you are using your unit, and a complete description of your station.

NOTES: